



**KAINDL**

BOARDS. FLOORS. IDEAS.

# INSTALLATION INSTRUCTIONS



## This installation profile is for:

Product group	Product	Plank Format	Thickness	Addition
Solid Pro	Compact Plank	1210 x 192 mm	5.0	
Solid Pro	Compact Tile	600 x 295 mm	5.0	
Solid Pro	Compact Plank	1210 x 192 mm	4.0	
Solid Pro Masterfloor	Wide Plank	1280 x 295 mm	4.0	

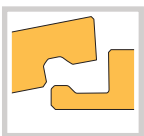

**Installation profile**

Solid Pro SPC



Kaindl Solid Pro SPC is manufactured during a series of defined, high-precision work steps. Semi-finished and finished products are subject to strict and continuous quality inspections. However, damage to individual elements, for instance through transport, cannot be completely ruled out. Please check the condition of the flooring elements prior to installation

Pay attention to the relatively high weight of the packages during transport. The following tips will help you transport packages with as little strain as possible on your back: - Stabilise your spine: keep your back straight and tension your core muscles and pelvic muscles.

Use your leg strength to lift the load. - Avoid jerky movements and twisting your waist: If something needs to be moved, lift it up, take a step to the side and put it down again. First, move obstacles out of the way and make space.



### Preparation:

Prior to installation, store the packages in the same climatic conditions as will prevail during installation and subsequent use [1]. Do not store in direct sunlight in front of the window.

Conditioning requirements:

- Stacked, with each layer turned by 90°
- Store for at least 48 hours
- Flat on the floor with a minimum distance of 50 cm to all walls and absolutely level

Always ensure panels are processed with care. Work with both hands and avoid pushing panels with your feet as it can damage the profiles.

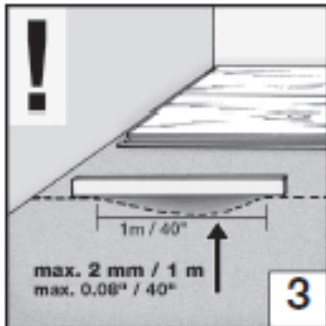

### Material and tools needed:

Use original accessories for the flooring. The following tools and aids should be used: pencil, folding rule, spirit level and spacers (1 mm, 10 mm), tapping block, hammer [2]. A craftsman's knife and a hand saw are recommended as cutting tools. The saw blade should be fine-toothed. A fine-toothed jigsaw or circular saw can also be used. Caution! Cut and broken edges can be sharp; carelessness can lead to injury. Skirting with the same decor is available as an accessory for the wall connections. Make sure the floor's movement is not restricted and that no moisture enters the floor joints in wet rooms.

Note: To bring the planks into the desired shape according to their width, scribe the required cutting edge with a cutter knife. The board can then easily be broken with your hands at this point.

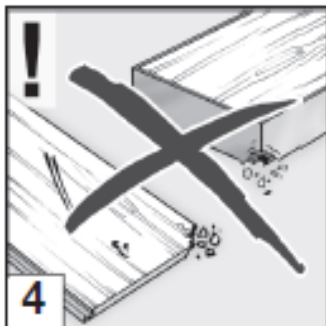

Installation subsurface and sealing: This product is suitable for wet rooms. Pursuant to DIN 68800, wet rooms are rooms with a long-term or permanent air humidity more than 70%. Kaindl Solid Pro SPC is not suitable for use outdoors or in wet areas. Typical areas of use include living rooms, bedrooms, bathrooms, kitchens, dining rooms, hallways, offices, shops, lobbies, medical practices, hotels and corridors. All other applications are at own risk and responsibility and exclude claims under warranty and guarantee.

The subsurface on which the panels are to be installed must enable the floor panels to be installed in accordance with the manufacturer's instructions (product insert). Mineral substrates (e.g. screed, water-based heated screed, concrete, asphalt) count among the suitable substrates. Please note that substructures must comply with the generally recognised rules for dry constructions in wet rooms.

The subsurface must be absolutely level, dry, clean and have load-bearing capacity. Subsurface unevenness of more than 2 mm over a length of at least 1 m must be professionally equalised (in accordance with DIN 18202) [3]. Subsurface unevenness is best checked using a straight edge or a 250 cm long spirit level in accordance with current standards. Ensure there are no ledges, steps or similar unevenness. Construction site contamination such as plaster and render residue, etc., must be removed completely. The application of a spreadable seal is recommended in wet rooms to permanently seal wall connections and floor substrates of all kinds. Express reference is made to the German language publication ZDB Merkblatt (01/2010) „Hinweise für die Ausführung von flüssig zu verarbeitenden Verbundabdichtungen mit Bekleidungen und Belägen aus Fliesen und Platten für den Innen- und Außenbereich“ with regard to processing substrates, in particular sealing wall and floors in wet rooms. The floor covering is not permanently waterproof because of the Click profiles. A PE film glued to the butt joints can be used as a preventive measure against moisture penetrating into the subsurface.

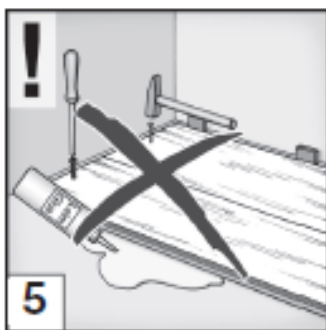

Check the panels in good daylight for defects [4]. Panels with visible defects outside of permissible tolerances, such as deviations in height, gloss, dimensions and colouration should be put to one side and will be replaced by the manufacturer free of charge. Warranty claims cannot be raised for panels that have been processed or installed. The product is installed as a floating surface and must not be screwed, nailed or glued to the subsurface or held in place using door stoppers or heavy objects [5].

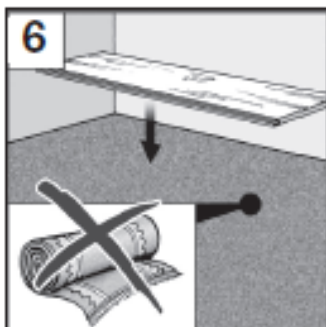

Carpeting, foamed PVC floor coverings and all types of foam must always be removed [6] as they are not suitable as substrates. Walking on the floor surface may otherwise cause a springy movement in the flooring and too much pressure in the edge areas, which can result in the formation of gaps. Carpeting must also be removed for hygienic reasons. Moisture can lead to the formation of mould and bacteria.

For commercial use it is necessary to lay the floor directly on the subfloor. An underlay mat can be used in the more heavily used private area.

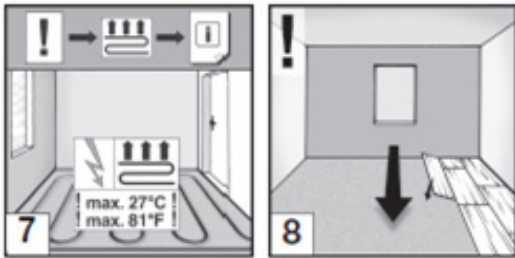

Underfloor heating systems (hot water/electric) is only possible if they are properly installed and used only in accordance with the manufacturer's instructions. The delivery and installation of underfloor heating must comply with the current state of the art and must be taken into operation by a professional in accordance with the relevant heating criteria. Underfloor heating must be installed and operated throughout the entire area of the room. Underfloor heating with partial functionality is not permissible. The temperature of 27°C on the underside of the flooring must never be exceeded at any location [7].

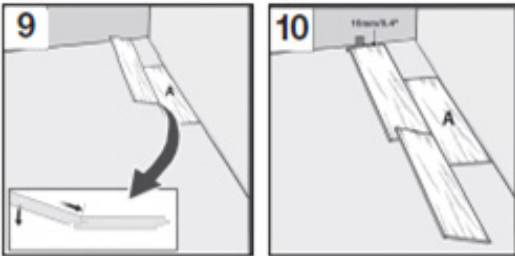

It is essential to avoid heat accumulating beneath potentially covered areas, e.g. carpets or rugs. Claims under warranty or guarantee or another type of claim are excluded in connection with the installation or operation of underfloor heating. Claims may only be made within the scope of our general warranty and guarantee conditions. The professional installer must make and document the CM measurement for floors with and without underfloor prior to installation. The following limit values apply to residual humidity:

- For calcium sulphate screeds: max. 0.5% CM without underfloor heating and 0.3% CM with underfloor heating
- For concrete screeds: max. 2.0% CM without underfloor heating and 1.8% CM with underfloor heating

**Installation:**

It is recommendable prior to installation to sort the panels according to the desired grain pattern and, where applicable, by decor design. Also take colour changes into consideration.

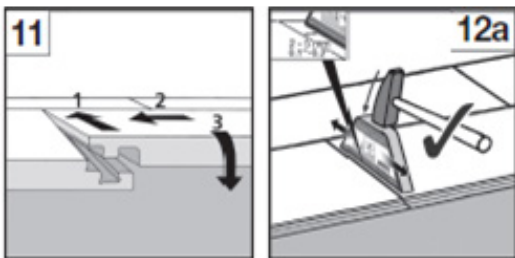

Make sure the installation is free from stress and tension. A circumferential edge distance of 5-10 mm to walls, pillars, etc., is strictly mandatory in this regard [10]. For instance, an installation length of 8 m must have a circumferential gap of at least 5 mm, while the maximum installation length of 20 m requires a circumferential gap of at least 10 mm. Movement joints must not be filled with cables or other materials. Expansion joints must always be installed between rooms and in rooms with complex floor layouts. For instance, a floor separator must be fitted if a living room connects to a bedroom, i.e. rooms with different usage temperatures. Failure to do so can result in tension and subsequent damage to the flooring. When laying, care must be taken that no cutting residues remain in the tongue and groove area, as otherwise the joint can no longer be closed with a correct fit due to the precise milling.

According to the current state of the art, all technically necessary joints in the sub-surface must be mapped in the floor covering, for instance movement joints between screeds. Covering these joints can result in damage to the flooring. Temperature fluctuations should be kept as low as possible. All methods of fixing the flooring in place are prohibited.

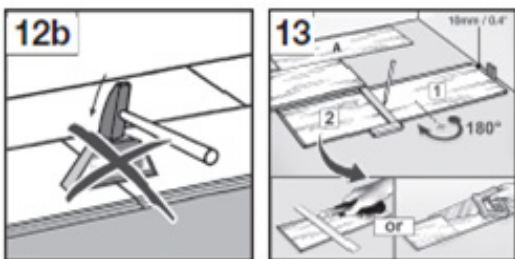

Recommendation: Install the panels longitudinally to the main source of light. The high-precision decor printing method achieves a natural variety of colours. You should therefore always install a mix of panels from different packages as this allows you to influence the effect of colour in your room flooring.

First of all, measure the space unit to establish whether the width of the first row of panels needs to be reduced. If the walls do not run straight, please transfer the run of the wall to the first row of panels and cut the panels to size. If the last row of panels has a width of less than 19.2 cm you should transfer the remaining dimension evenly between the first and last row of panels so that both rows are cut to size with the same panel width. If the remaining dimension is less than 10 cm you should transfer the available dimension evenly to the first and last row of panels so that both rows are cut to size with the same panel width. The tongue and groove profiles do not count towards the expansion joint and must be removed. Please check which is the tongue side and groove side on each element.

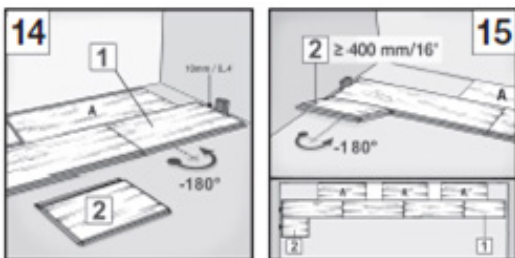

Start laying from the left-hand corner of the room. Lay the first panel with the short and long tongue sides facing the walls and use spacers to fix the distance to the wall [9]. Click the tongue on the face side (short side) of a second panel into the groove profile of the preceding first panel by laying it against the opposite profile side of the first panel [10] and tapping it into place with a tapping block and hammer [12a]. Make sure the longitudinal edges are flush, do not form an offset and result in a straight line. This is necessary in order to insert the panels into the longitudinal profile without any gaps when laying the 2nd row. Click further panels into place up to the end of the first row.

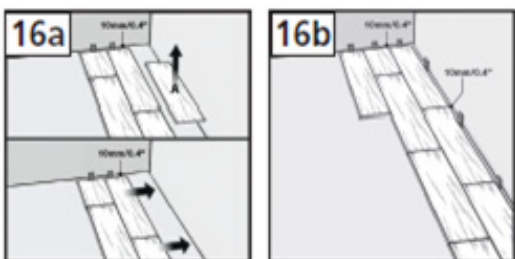

Turn the last panel in the row by 180° for fitting or cutting to size [13] and place it with the decor side up next to the existing row (groove against groove) and wall side. Take an edge distance of 5-10 mm into account on the face side. Mark the panel length and cut to size. Make sure the decor side of the panel is facing down when cutting with a jigsaw or circular saw to avoid splitting the edges. Otherwise cut from the upper side of the panel. Start each row with the remaining piece from the previous row (at least 40 cm in length) [15].

Start the second row with a half-panel or the remaining piece from the 1st row. Please note that the panel must not be smaller than 40 cm and not longer than 90 cm. The joint offset (transverse joint offset) must be at least 40 cm from row to row (pay attention to the joint image when laying stone decors). Position the panel piece

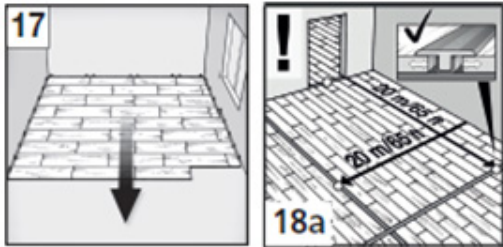

of the second row so that the longitudinal sides of the 1st and 2nd row are on top of one another in parallel. Lift up the panel piece on the longitudinal side (groove side) facing into the room by 30 to 40 mm (at an angle of approx. 20°). The tongue of the panel in the 2nd row slides into the groove of the 1st row in the raised area. Lower the element carefully until it is flat on the subsurface. To install the second panel of the second row, first position the tongue on its longitudinal side at an angle from above against the longitudinal groove of the first row (at an angle of approx. 20°). Slide this element in its angled position up to the face side of the first panel in the second row until the tongue and groove on the face side of the second panel match up. Now carefully lower the panel until the profiles are on top of one another. Take the tapping block and position it directly above the profile in parallel to the short side and tap the tapping block with a hammer to lock the profile into place [11,12a].

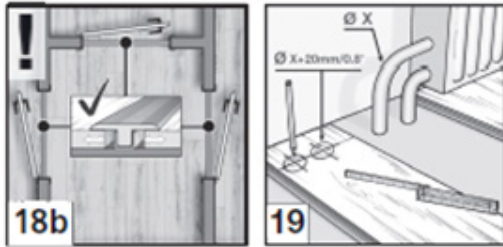

Repeat the process along the length of the 2nd row (zip fashion) until rows 1 and 2 are connected with no gaps and no offset in height. Make sure there is no longitudinal offset between panels when connecting rows 1 and 2 together. Further rows are added in the same way as row 2, allowing for an adequate transverse joint offset. When installing the last row against the wall, make sure it is free from tension (5-10 mm gap).

To accommodate heating pipes, cut out holes that are 10-20 mm larger than the heating pipe diameter [19]. Cut out a "fitting piece", apply adhesive, place it in position and hold in place with a wedge until the PVC glue cures [21]. Then cover up the cut-outs with radiator pipe collars.

Shorten door frames so that a panel fits underneath the door with 2-3 mm clearance [22, 23].

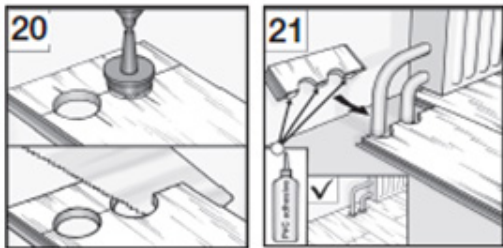

Remove spacers when installation is complete. To close the joint to the wall, attach the skirting rails to the wall and attach the cut-to-size skirting elements [26a]. Circumferential joints in wet rooms must be additionally sealed with silicone [27].

#### Use and care

Areas in front of open fireplaces should be adequately protected from radiated heat and glowing/falling ash and embers. Apply felt castors to all movable furniture immediately after installation. Use only soft, migration-free chair wheels (EN 12529 Type W) [30] with a light-coloured running surface. If necessary, place a protective mat in the movement radius.

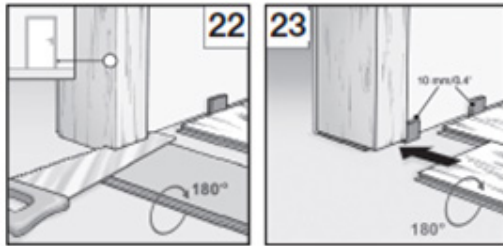

When used in conjunction with underfloor heating, make sure heat does not accumulate beneath covered areas (e.g. rugs and furniture). The maximum permissible temperature beneath a covered area is 27°C. Place flower pots, vases, et., on a waterproof base to prevent the formation of mould and subsequent discolouration.

**Caution!** Use an adequately sized dirt-trap mat in entrance areas to prevent grit and other materials on the soles of shoes that can damage the flooring from being carried into the room.

Immediately remove glass splinters and any other aggressive materials that can damage the floor. Spilt liquids should be cleared away as soon as possible. Car tyres and rubber mats can cause changes in the colour of light and medium decors. The use of special stain removers on staining substances (e.g. hair dye in hair salons) should therefore first be tested on a test piece. Discolourations that cannot be removed may otherwise occur.

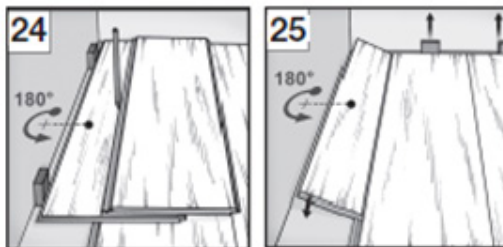

#### Cleaning

Pick up non-sticking dirt with a brush and dustpan or a vacuum cleaner suitable for hard flooring.

After completion of installation work and for basic cleaning and maintenance cleaning use the Kaindl Flooring Cleaner.

#### Cleaning after installation and basic cleaning:

Remove coarse dirt by sweeping or vacuum cleaning. Dilute Kaindl flooring Cleaner accordingly.

Spread the cleaning solution on the flooring, allow to work briefly and then clean. Pick up loosened dirt with a broad mop or use a spray extractor cleaning appliance fitted with hard floor adapter on larger surface areas. Then mop with clear water to neutralise.

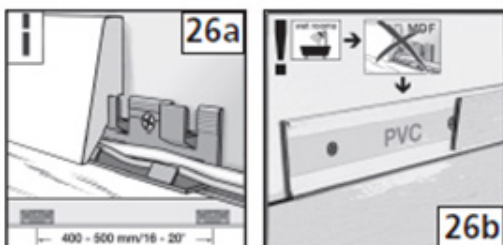

#### Maintenance cleaning:

Dilute Kaindl flooring Cleaner accordingly and mop the floor with the solution.



**General:**

Always clean structured surface in the direction of the structured pattern. Mop up footprints and dirt with a wrung wet cloth.

Polishes and cleaning agents containing additives such as wax, oil, etc., are not suitable for cleaning the floor surface. Do not polish the floor surface. Please do not use a steam cleaner, a wire or nylon scrubbing sponge, furniture polish, powdery or liquid scrubbing agents, bleach or other strong cleaning agents.

Taking these notes into consideration will help maintain the value of your flooring as well as your full entitlement to warranty services.

**Replacing and removing elements**

Replacing or removing floating panels in private and commercial premises is achieved by first lifting the entire row longitudinally at an angle [31] to unlock it. The panels are then removed from the head end also by lifting them at an angle to unlock them [32]. Please work conscientiously and with great care to avoid damaging the tongue and groove sections.

**Disposal**

Contact your regional waste disposal company to have the material recycled.

**Warranty information**

For information about Kaindl's 3-fold warranty on abrasion, light-fastness and stain insensitivity, please see Kaindl's warranty conditions.

<http://www.kaindl.com>

<http://www.zdb.de/zdb.nsf/0/F379B86C6C1F8306C12576BA003497AC>

(Status: november 2019)